



INSTRUCTION MANUAL

VHF TRANSCEIVER

IC-F14/S

UHF TRANSCEIVER

IC-F24/S

This device complies with Part 15 of the FCC rules. Operation is subject to the condition that this device does not cause harmful interference.

Icom Inc.



SAFETY TRAINING INFORMATION



WARNING

Your Icom radio generates RF electromagnetic energy during transmit mode. This radio is designed for and classified as “Occupational Use Only”, meaning it must be used only during the course of employment by individuals aware of the hazards, and the ways to minimize such hazards. This radio is NOT intended for use by the “General Population” in an uncontrolled environment.

This radio has been tested and complies with the FCC RF exposure limits for “Occupational Use Only”. In addition, your Icom radio complies with the following Standards and Guidelines with regard to RF energy and electromagnetic energy levels and evaluation of such levels for exposure to humans:

- FCC OET Bulletin 65 Edition 97-01 Supplement C, Evaluating Compliance with FCC Guidelines for Human Exposure to Radio Frequency Electromagnetic Fields.
- American National Standards Institute (C95.1-1992), IEEE Standard for Safety Levels with Respect to Human Exposure to Radio Frequency Electromagnetic Fields, 3 kHz to 300 GHz.
- American National Standards Institute (C95.3-1992), IEEE Recommended Practice for the Measurement of Potentially Hazardous Electromagnetic Fields— RF and Microwave.
- The following accessories are authorized for use with this product. Use of accessories other than those specified may result in RF exposure levels exceeding the FCC requirements for wireless RF exposure.; Belt Clip (MB-94), Rechargeable Li-Ion Battery Pack (BP-231/BP-232) and Speaker-microphone (HM-131L).



CAUTION

To ensure that your exposure to RF electromagnetic energy is within the FCC allowable limits for occupational use, always adhere to the following guidelines:

-
- **DO NOT** operate the radio without a proper antenna attached, as this may damaged the radio and may also cause you to exceed FCC RF exposure limits. A proper antenna is the antenna supplied with this radio by the manufacturer or antenna specifically authorized by the manufacturer for use with this radio.
 - **DO NOT** transmit for more than 50% of total radio use time (“50% duty cycle”). Transmitting more than 50% of the time can cause FCC RF exposure compliance requirements to be exceeded. The radio is transmitting when the “Transmit indicator” lights red. You can cause the radio to transmit by pressing the “PTT” switch or VOX function.
 - **ALWAYS keep** the antenna at least 2.5 cm (1 inch) away from the body when transmitting and only use the Icom belt-clip which is listed on page 31 when attaching the radio to your belt, etc., to ensure FCC RF exposure compliance requirements are not exceeded. To provide the recipients of your transmission the best sound quality, hold the antenna at least 5 cm (2 inches) from your mouth, and slightly off to one side.

The information listed above provides the user with the information needed to make him or her aware of RF exposure, and what to do to assure that this radio operates with the FCC RF exposure limits of this radio.

Electromagnetic Interference/Compatibility

During transmissions, your Icom radio generates RF energy that can possibly cause interference with other devices or systems. To avoid such interference, turn off the radio in areas where signs are posted to do so. **DO NOT** operate the transmitter in areas that are sensitive to electromagnetic radiation such as hospitals, aircraft, and blasting sites.

Occupational/Controlled Use

The radio transmitter is used in situations in which persons are exposed as consequence of their employment provided those persons are fully aware of the potential for exposure and can exercise control over their exposure.

FOREWORD

READ ALL INSTRUCTIONS carefully and completely before using the transceiver.

SAVE THIS INSTRUCTION MANUAL— This instruction manual contains important operating instructions for the IC-F14/F14S VHF TRANSCEIVER and IC-F24/F24S UHF TRANSCEIVER.

EXPLICIT DEFINITIONS

WORD	DEFINITION
⚠ WARNING	Personal injury, fire hazard or electric shock may occur.
CAUTION	Equipment damage may occur.
NOTE	If disregarded, inconvenience only. No risk of personal injury, fire or electric shock.

OPERATING NOTES

- When transmitting with a portable radio, hold the radio in a vertical position with its microphone 5 to 10 centimeters (2 to 4 inches) away from your mouth. Keep the antenna at least 2.5 centimeters (1 inch) from your head and body.
- If you wear a portable two-way radio on your body, ensure that the antenna is at least 2.5 centimeters (1 inch) from your body when transmitting.

PRECAUTION

⚠ WARNING! NEVER hold the transceiver so that the antenna is very close to, or touching exposed parts of the body, especially the face or eyes, while transmitting. The transceiver will perform best if the microphone is 5 to 10 cm (2 to 4 inches) away from the lips and the transceiver is vertical.

⚠ WARNING! NEVER operate the transceiver with a headset or other audio accessories at high volume levels.

CAUTION! NEVER short the terminals of the battery pack.

NEVER connect the transceiver to a power source other than the BP-230, BP-231 or BP-232. Such a connection will ruin the transceiver.

DO NOT push the PTT when not actually desiring to transmit.

AVOID using or placing the transceiver in direct sunlight or in areas with temperatures below -22°F (-30°C) or above $+140^{\circ}\text{F}$ ($+60^{\circ}\text{C}$).

DO NOT modify the transceiver for any reason.

MAKE SURE the flexible antenna and battery pack are securely attached to the transceiver, and that the antenna and battery pack are dry before attachment. Exposing the inside of the transceiver to water will result in serious damage to the transceiver.

The use of non-Icom battery packs/chargers may impair transceiver performance and invalidate the warranty.

FCC caution:

Changes or modifications to this device, not expressly approved by Icom Inc., could void your authority to operate this transceiver under FCC regulations.

Icom, Icom Inc. and the  ICOM logo are registered trademarks of Icom Incorporated (Japan) in the United States, the United Kingdom, Germany, France, Spain, Russia and/or other countries.

TABLE OF CONTENTS

SAFETY TRAINING INFORMATION	i
FOREWORD	iii
EXPLICIT DEFINITIONS	iii
OPERATING NOTES	iii
PRECAUTION	iv
TABLE OF CONTENTS	v
1 ACCESSORIES	1-5
■ Supplied accessories.....	1
■ Accessory attachments	2
2 PANEL DESCRIPTION	6-11
■ Front, top and side panels	6
■ LED indicator	8
■ Programmable function keys	9
3 CONVENTIONAL OPERATION	12-18
■ Turning power ON	12
■ Channel selection	12
■ Call procedure	13
■ Receiving and transmitting	14
■ Scrambler function	16
■ Setting the squelch level	16
■ Man Down Emergency Call	17
4 OPTIONAL UNIT INSTALLATION	18-19
■ Optional unit installation	18
■ Scrambler unit installation	19
5 BATTERY CHARGING	20-25
■ Battery charging	20
■ Caution	21
■ Optional battery chargers	22
6 SWIVEL BELT CLIP	26-29
■ MB-93 contents	26
■ To attach	26
■ To detach	28
7 OPTIONS	30-32

ACCESSORIES 1

■ Supplied accessories

The following accessories are supplied: Qty.

- ① Flexible antenna1
- ② Battery pack1
- ③ Belt clip1
- ④ Unit cover (double-sided tape)*1
- ⑤ Jack cover (with screws)1 set

*Use the unit cover as a spare. Ask your dealer for details.

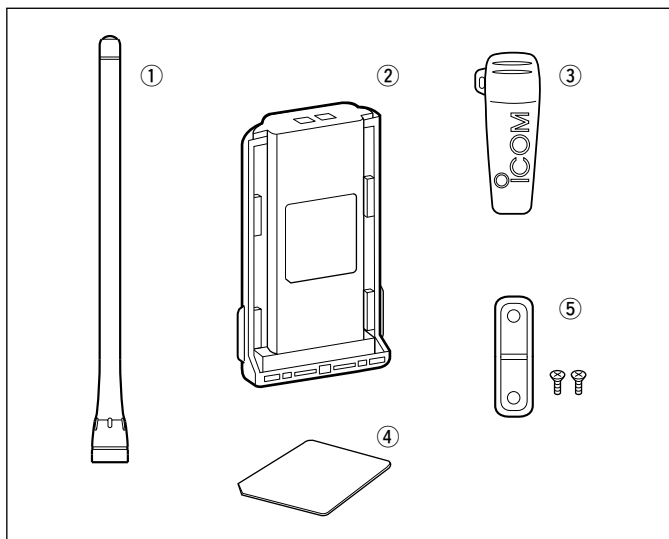

■ Accessory attachments

◇ Flexible antenna

Connect the supplied flexible antenna to the antenna connector.

CAUTION:

- **NEVER HOLD** by the antenna when carrying the transceiver.
- Transmitting without an antenna may damage the transceiver.

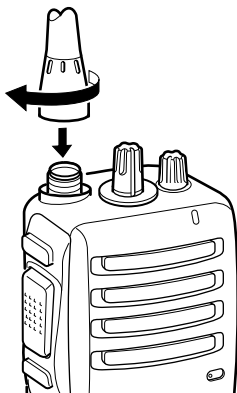

◇ Battery pack

To attach the battery pack:

Slide the battery pack on the back of the transceiver in the direction of the arrow (1), then lock it with the battery release button.

- Slide the battery pack until the battery release button makes a 'click' sound.

To release the battery pack:

Push the battery release button in the direction of the arrow (2) as shown below. The battery pack is then released.

/// **NEVER** release or attach the battery pack when the transceiver is wet or soiled. This may result in water or dust getting into the transceiver/battery pack and may result in the transceiver being damaged.

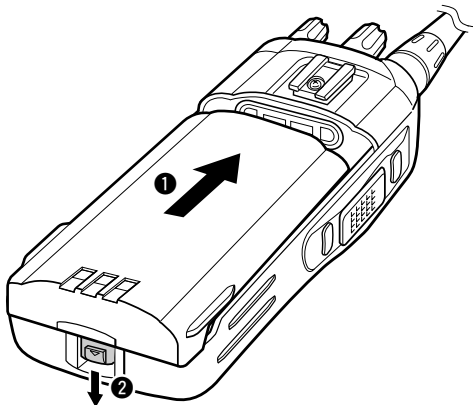

1 ACCESSORIES

◇ Jack cover

Attach the jack cover when the optional speaker-microphone is not used.

To attach the jack cover:

- 1 Attach the jack cover to the [SP MIC] connector.
- 2 Tighten the screws.

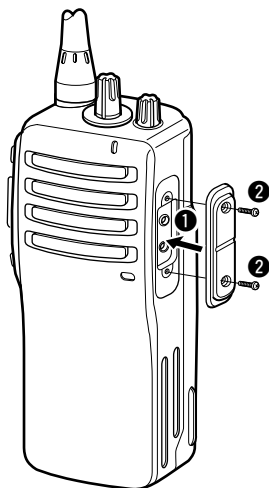

To detach the jack cover:

- 1 Unscrew the screws with a phillips screwdriver.
- 2 Detach the jack cover for the speaker-microphone connection.

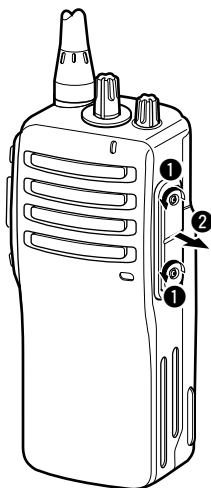

◇ Belt clip

To attach the belt clip:

- ① Release the battery pack if it is attached.
- ② Slide the belt clip in the direction of the arrow until the belt clip is locked and makes a 'click' sound.

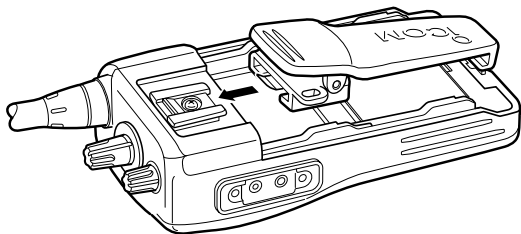

To detach the belt clip:

- ① Release the battery pack if it is attached.
- ② Pinch the clip (①), and slide the belt clip in the direction of the arrow (②).

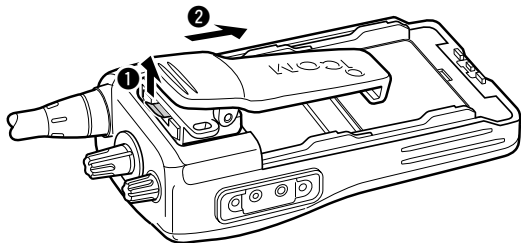

2 PANEL DESCRIPTION

■ Front, top and side panels

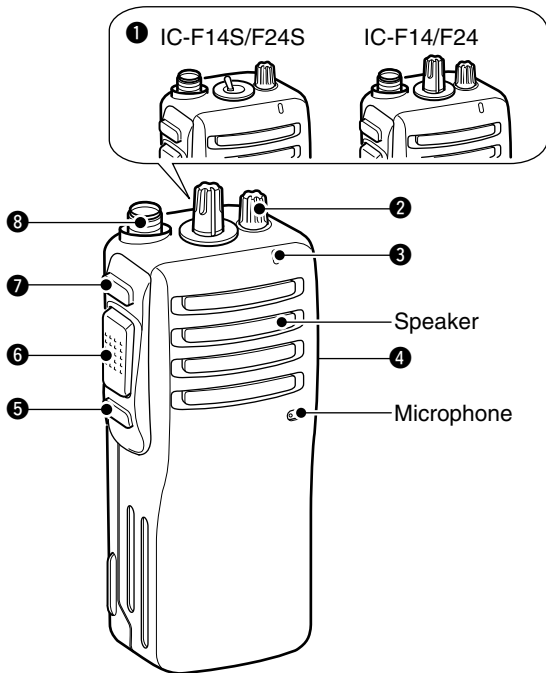

① CHANNEL SW/SELECTOR

- IC-F14S/F24S: Toggle the channel switch to select the pre-programmed channel 1 or 2.
- IC-F14/F24 : Rotate the channel selector to select the pre-programmed memory channels.

② VOLUME CONTROL [VOL]

Rotate to turn the power ON/OFF and adjust the audio level.

3 LED INDICATOR (p. 8)

- ➔ Lights red while transmitting.
- ➔ Lights green while receiving a signal, or when the squelch is open.
- ➔ Lights/blinks orange when the matched 2/5-tone code is received, according to the pre-programming.

4 SPEAKER-MICROPHONE CONNECTOR [SP MIC]

Connects the optional speaker-microphone. (p. 31)

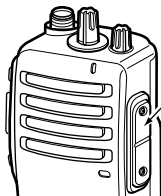

[SP MIC] jack cover

NOTE: Attach the [SP MIC] jack cover when the optional speaker-microphone is not used. (p. 4)

5 DEALER-PROGRAMMABLE KEY [Lower]

The desired function can be assigned by your dealer. (p. 9)

6 PTT SWITCH [PTT]

Push and hold to transmit; release to receive.

7 DEALER-PROGRAMMABLE KEY [Upper]

The desired function can be assigned by your dealer. (p. 9)

8 ANTENNA CONNECTOR

Connects the supplied antenna.

◇ Programmable key reference

Upper	
Lower	

■ LED indicator

The LED indicator indicates several information as follows;

(Ref.; R=Red, G=Green, O=Orange)

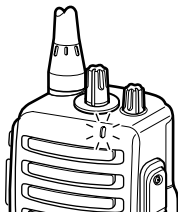

- TX: Turns Red while transmitting a signal.



- RX: Turns Green while receiving a signal.

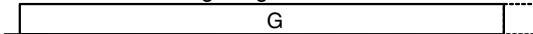

- Call LED (ON): When receiving a matched 2/5-tone.



- Call LED (Blink): When receiving a matched 2/5-tone.



- Fast/Slow scan: Blinks while Fast/Slow scan is activated.



- Low BATT1: You should charge the battery. (blinks slowly)



- Low BATT2: You must charge the battery. (blinks fast)

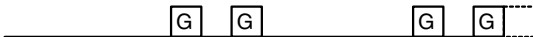

- TX low BATT2: Low BATT2 was detected during TX mode.



- CH err: Non-programmed channel is selected.



■ Programmable function keys

The following functions can be assigned to **[Upper]** and **[Lower]** programmable function keys.

Consult your Icom dealer or system operator for details concerning your transceivers programming.

If the programmable function names are bracketed in the following explanations, the specific key used to activate the function depends on programming.

SCAN A KEY

➤ This key's operation depends on the Power ON Scan setting.

When the power ON scan function is turned OFF;

Push to start and cancel scanning operation. In case of transmission during scan, cancels scanning.

When the power ON scan function is turned ON;

Push to pause scanning. Scanning resumes after passing a specified time period. In case of transmission during scan, pauses scanning. Scanning resumes after passing a specified time period.

SCAN B KEY

Push to start and cancel scanning operation. In case of transmission during scan, pauses scanning. Scanning resumes after passing a specified time period.

PRIORITY CHANNEL KEYS

➤ Push to select the Priority A or Priority B channel.

➤ Push and hold **[Prio A (Rewrite)]** to rewrite the Prio A channel.

MR-CH 1/2/3/4 KEYS

Push to select a memory channels 1 to 4 directly.

/// **NOTE:** The memory channels 3 and 4 are available for IC-F14S/F24S when **[MR-CH 3]** and **[MR-CH 4]** keys are assigned.

2 PANEL DESCRIPTION

MONITOR KEY

- Mute and release the CTCSS (DTCS) or 2-tone squelch mute. Open any squelch/deactivate any mute while pushing this key. (LMR operation only)
 - Activates one of (or two of) the following functions on each channel independently: (PMR operation only)
 - Push and hold to un-mute the channel (audio is emitted; 'Audible' condition).
 - Push to mute the channel (sets to 'Inaudible' only).
 - Push to un-mute the channel (sets to 'Audible' only).
 - Push after the communication is finished to send a 'reset code'.
-  **NOTE:** The un-mute condition ('Audible' condition) may automatically return to the mute condition ('Inaudible' condition) after a specified period.

LOCK KEY

Push and hold to electronically lock all programmable keys except the following:

[Call] (incl. Call A and Call B), **[Moni(Audi)]** and **[Emergency]** keys.

OUTPUT POWER SELECTION KEY

Select the transmit output power temporarily or permanently, depending on the pre-setting.

- Ask your dealer for the output power level for each selection.

TALK AROUND KEY

- Push to turn the talk around function OFF.
- Push and hold to turn the talk around function ON.
 - The talk around function equalizes the transmit frequency to the receive frequency for transceiver-to-transceiver communication.

WIDE/NARROW KEY

- Push to select the IF bandwidth to wide.
 - The wide passband width can be selected from 25.0 or 20.0 kHz using the CS-F14 CLONING SOFTWARE. (PMR operation only) Ask your dealer for details.
- Push and hold to select the IF bandwidth to narrow.

DTMF AUTODIAL KEY

Push to transmit the programmed DTMF code.

CALL KEYS

Push to transmit a 2/5-tone code.

- Call transmission is necessary before you call another station depending on your signalling system.
- **[Call A]** and/or **[Call B]** keys may be available when your system employs selective 'Individual/Group' calls. Ask your dealer which call is assigned to each key.

EMERGENCY KEYS

- Push and hold to transmit an emergency call.
- When **[Emergency Single (Silent)]** or **[Emergency Repeat (Silent)]** is pushed, an emergency call is transmitted without a beep emission.
 - If you want to cancel the emergency call, push (or push and hold) the key again before transmitting the call.
 - The emergency call is transmitted one time only or repeatedly until receiving a control code depending on the pre-setting.

VOICE SCRAMBLER FUNCTION KEYS

- Push to turn the voice scrambler function OFF.
- Push and hold to turn the voice scrambler function ON.

OPT OUT KEYS

- Push to inactivate the connected output signal level.
- Push and hold to activate the connected output signal level.

SIREN KEY

Push to emit a siren. This function can be used for situations other than an emergency alert such as a security alarm for example.

3 CONVENTIONAL OPERATION

■ Turning power ON

→ Rotate [VOL] to turn power ON.

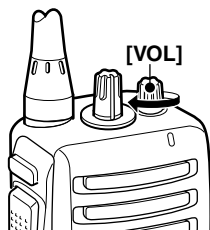

■ Channel selection

IC-F14S/F24S:

Toggle [CHANNEL SWITCH] to select the channel 1 or 2, or, push one of [MR-CH 1] to [MR-CH 4] key to select a channel directly.

- The memory channels 3 and 4 are available when [MR-CH 3] and [MR-CH 4] keys are assigned.

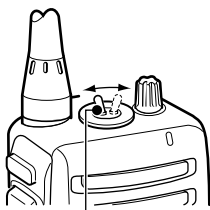

[CHANNEL SWITCH]

IC-F14/F24:

Rotate [CHANNEL SELECTOR] to select the desired operating channel, in sequence; or, push one of [MR-CH 1] to [MR-CH 4] key to select a channel directly.

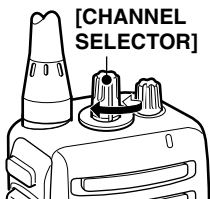

AUTOMATIC SCAN TYPE:

Channel setting is not necessary for this type. When turning the power ON, the transceiver automatically starts scanning. Scanning stops when receiving a call.

■ Call procedure

When your system employs tone signalling (excluding CTCSS and DTCS), the call procedure may be necessary prior to voice transmission. The tone signalling employed may be a selective calling system which allows you to call specific station(s) only and prevent unwanted stations from contacting you.

- ① Select the desired TX code channel or 2/5-tone code according to your System Operator's instructions.
 - This may not be necessary depending on programming.
- ② Push the call key (assigned to one of the dealer programmable keys.) (p. 11)
- ③ After transmitting a 2/5-tone code, the remainder of your communication can be carried out in the normal fashion.

Selective calling

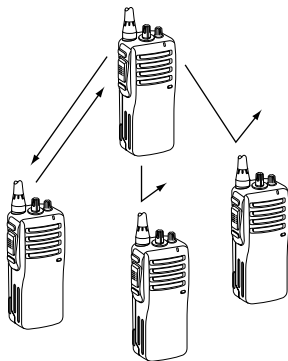

Non-selective calling

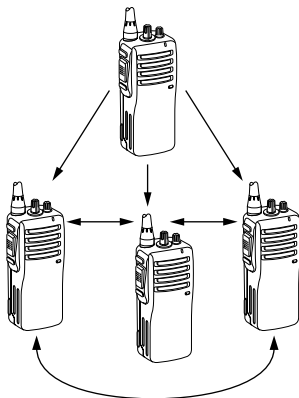

■ Receiving and transmitting

/// **NOTE:** Transmitting without an antenna may damage the transceiver. See p. 2 for antenna attachment.

Receiving:

- ① Rotate [**VOL**] to turn power ON.
- ② Toggle [**CHANNEL SWITCH**] (IC-F14S/F24S), rotate [**CHANNEL SELECTOR**] (IC-F14/F24) or push one of [**MR-CH 1**] to [**MR-CH 4**] key to select a channel.
/// **For IC-F14S/F24S:**
/// The memory channels 3 and 4 are available when [**MR-CH 3**] and [**MR-CH 4**] keys are assigned.
- ③ When receiving a call, adjust the audio output level to a comfortable listening level.

Transmitting:

Wait for the channel to become clear to avoid interference.

- ① While pushing and holding [**PTT**], speak into the microphone at a normal voice level.
 - When a tone signalling system is used, the call procedure described on p. 13 may be necessary.
- ② Release [**PTT**] to return to receive.

/// **IMPORTANT!:** To maximize the readability of your signal;

1. Pause briefly after pushing [**PTT**].
2. Hold the microphone 5 to 10 cm (2 to 4 inches) from your mouth, then speak into the microphone at a normal voice level.

◇ Transmitting notes

• Transmit inhibit function

The transceiver has several inhibit functions which restrict transmission under the following conditions:

- The channel is in mute condition.
- Channel is busy.
- Un-matched (or matched) CTCSS is received.
- The selected channel is a 'receive only' channel.

• Time-out timer

After continuous transmission for the pre-programmed time period, the time-out timer activates, and causes the transceiver to stop transmitting.

• Penalty timer

Once the time-out timer activates, transmission is further inhibited for a period determined by the penalty timer.

◇ DTMF transmission

If the transceiver has **[DTMF Autodial]** assigned to it, the automatic DTMF transmission function is available.

➡ Push **[DTMF Autodial]** to transmit the DTMF code.

■ Scrambler function

The optional voice scrambler units UT-109 (#01) and UT-110 (#01) provide high performance private communication between stations with the same scrambler codes.

- ➔ Push and hold [**Scrambler**] to turn the scrambler function ON.
- ➔ Push [**Scrambler**] to turn the scrambler function OFF.

■ Setting the squelch level

The squelch circuit mutes the received audio signal depending on the signal strength.

- ① While pushing [**PTT**] and [**Lower**], rotate [**VOL**] to turn the power ON to enter the squelch level adjustment mode.
- ② Push [**Upper**] to increase the squelch level (tight squelch) or [**Lower**] to decrease the squelch level (loose squelch).
- ③ Rotate [**VOL**] to turn the power OFF to fix the squelch level.

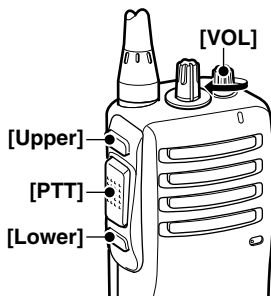

■ Man Down Emergency Call

The man down emergency call function transmits an emergency call automatically, after the transceiver laying down in a horizontal position for a pre-set time period. (The optional UT-113 MAN DOWN UNIT is required.)

After the emergency call, the transceiver performs transmission and reception alternately with the following conditions:

- Transmits the microphone signals.
- Receives the signal and emits audio.

When the emergency cancel code is received, the function is cancelled.

/// IMPORTANT!: Set an emergency channel individually, to provide certain emergency call operation is recommended.

4 OPTIONAL UNIT INSTALLATION

Optional unit installation

Install the optional unit as follows:

- ① Rotate **[VOL]** to turn the power OFF, and remove the battery pack. (p. 3)
- ② Remove the unit cover.

NOTE: Use a flat head screw driver or a similar flat instrument, and insert into the hollow of the chassis, then lift and take away the unit cover. (The removed cover cannot be used again.)

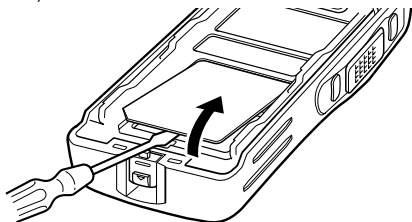

- ③ Install the unit as shown below.

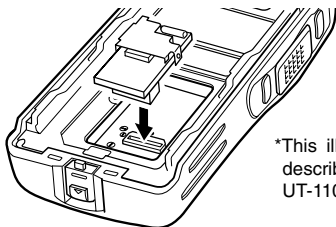

*This illustration is described with the UT-110.

- ④ Replace the unit cover and the battery pack, then rotate **[VOL]** to turn the power ON.

NOTE: The optional UT-109/UT-110 SCRAMBLER UNITS requires some PC board modifications. Please refer to the additional installation as at right.

■ Scrambler unit installation

The following PC board modification is required when installing the optional UT-109 or UT-110.

- ① Rotate [VOL] to turn the power OFF, and remove the battery pack. (p. 3)
- ② Remove the unit cover as shown at left (Optional unit installation.)
- ③ Cut the pattern on the PCB at the TX mic circuit (MIC) and RX AF circuit (DISC) as shown below.
- ④ Install the scrambler unit as shown at left (Optional unit installation.)
- ⑤ Replace the unit cover and the battery pack, then rotate [VOL] to turn the power ON.

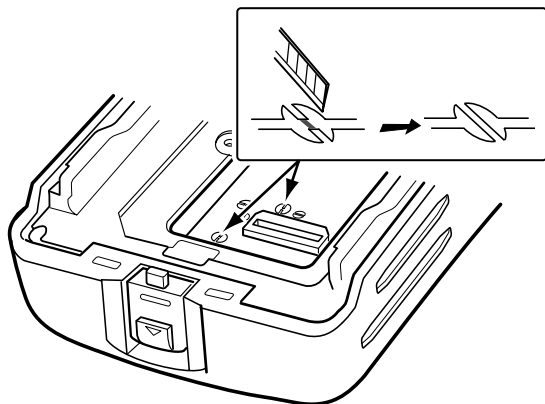

NOTE: When uninstalling the scrambler unit

Be sure to re-solder the disconnected points at left, otherwise no TX modulation or AF output is available.

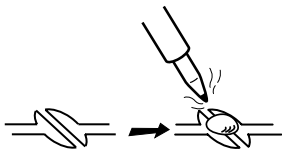

5 BATTERY CHARGING

■ Battery charging

Prior to using the transceiver for the first time, the battery pack must be fully charged for optimum life and operation.

/// **CAUTION:** To avoid damage to the transceiver, turn it OFF while charging.

- Recommended temperature range for charging:
 - +10°C to +40°C (+50°F to +104°F)
 - The Li-Ion battery functions within -20°C to +60°C (-4°F to +140°F)
- Use the specified chargers (BC-119N, BC-121N and BC-160). **NEVER** use another manufacturer's charger.
- Use the optional AC adapter. **NEVER** use another manufacturer's AC adapter.

Recommendation:

Charge the supplied battery pack for a maximum of up to 10 hours. Li-Ion batteries are different from Ni-Cd batteries in that it is not necessary to completely charge and discharge them to prolong the battery life. Therefore, charging the battery in intervals, and not for extended periods is recommended.

■ Caution

⚠ DANGER Charge the specified Icom batteries only.

Only tested and approved for use with genuine Icom batteries. Fire and/or explosion may occur when a third party battery pack or counterfeit product is charged.

CAUTION! NEVER insert battery pack/transceiver (with the battery pack attached) with wet or soiled into the charger. This may result in corrosion of the charger terminals or damage to the charger. The charger is not waterproof and water can easily get into it.

NEVER incinerate used battery packs. Internal battery gas may cause an explosion.

NEVER immerse the battery pack in water. If the battery pack becomes wet, be sure to wipe it dry immediately (particularly the battery terminals) BEFORE attaching it to the transceiver. Otherwise, the terminals will become corroded, or cause connection failure, etc.

NEVER short the terminals of the battery pack. Also, current may flow into nearby metal objects, such as a necklace, etc. Therefore, be careful when carrying with, or placing near metal objects, carrying in handbags, etc.

AVOID leaving the battery pack in a fully charged, or completely discharged condition for long time. It causes shorter battery life. In case of leaving the battery pack unused for a long time, it must be kept safely after discharge, or use the battery until the battery indicator appears, then remove it from the transceiver.

If your battery pack seems to have no capacity even after being charged, fully charge the battery pack again. If the battery pack still does not retain a charge (or very little), a new battery pack must be purchased.

■ Optional battery chargers

◇ Rapid charging with the BC-160

The optional BC-160 provides rapid charging of optional Li-Ion battery packs.

- An AC adapter (may be supplied with BC-160 depending on version) or the DC power cable (OPC-515L/CP-17L) is additionally required.

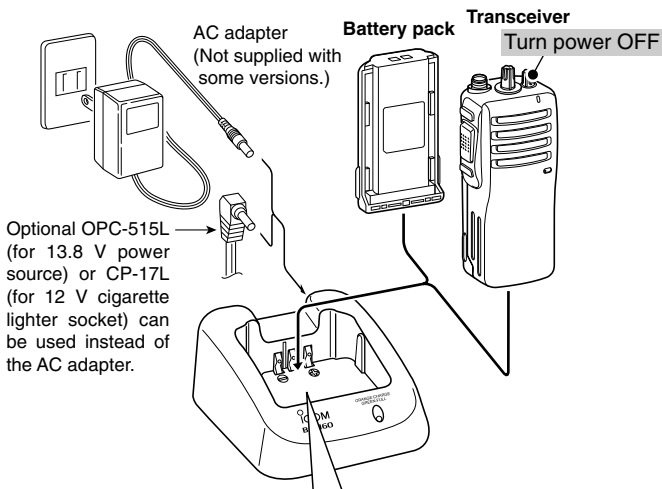

IMPORTANT!:

Ensure the guide lobes on the battery pack are correctly aligned with the guide rails inside the charger adapter.

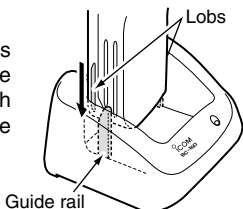

◆ AD-106 installation

- ① Install the AD-106 desktop charger adapter into the holder space of the BC-119N/121N.

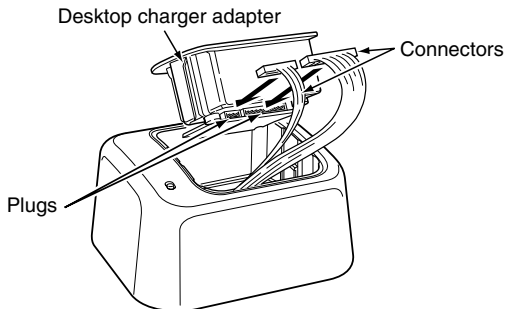

- ② Connect the plugs of the BC-119N/BC-121N to the AD-106 with the connector, then install the adapter into the charger with the supplied screws.

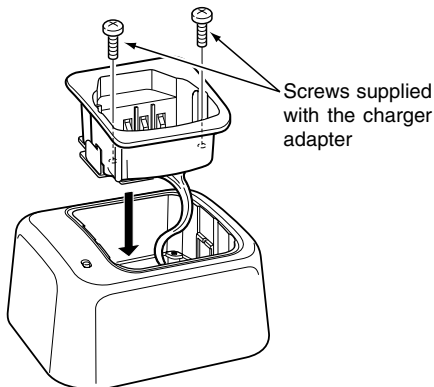

5 BATTERY CHARGING

◇ Rapid charging with the BC-119N+AD-106

The optional BC-119N provides rapid charging of optional Li-Ion battery packs.

The following items are additionally required:

- One AD-106 (purchase separately).
- An AC adapter (may be supplied with BC-119N depending on version) or the DC power cable (OPC-515L/CP-17L).

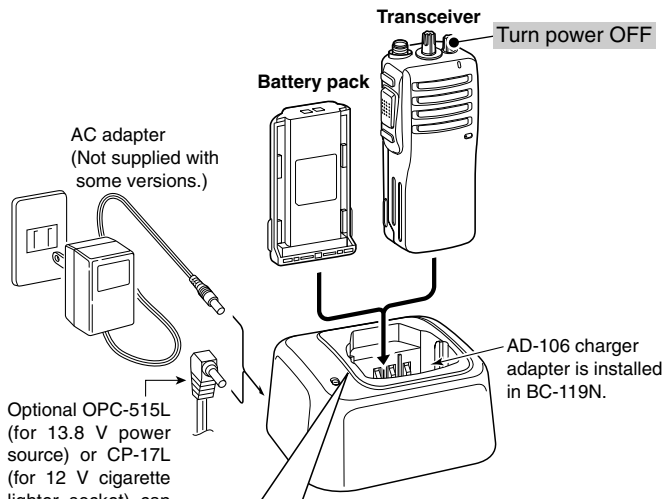

IMPORTANT!

Ensure the guide lobes on the battery pack are correctly aligned with the guide rails inside the charger adapter.

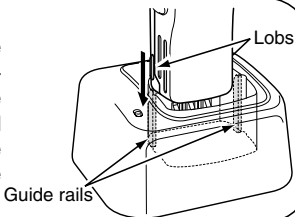

◇ Rapid charging with the BC-121N+AD-106

The optional BC-121N allows up to 6 battery packs to be charged simultaneously. The following items are additionally required.

- Six AD-106.
- An AC adapter (BC-157) or the DC power cable (OPC-656)

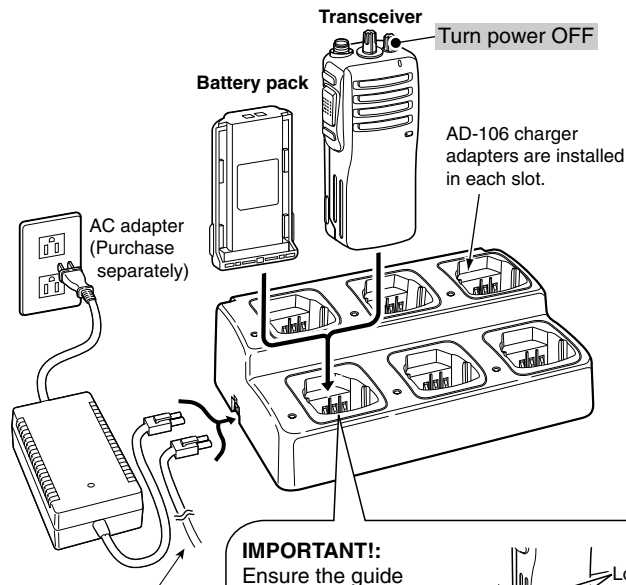

DC power cable (OPC-656)
(Connect with the DC power supply; 13.8 V/at least 7 A)

IMPORTANT!:

Ensure the guide lobes on the battery pack are correctly aligned with the guide rails inside the charger adapter.

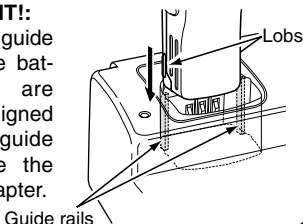

6 SWIVEL BELT CLIP

■ MB-93 contents

	Qty.
① Belt clip	1
② Base clip	1

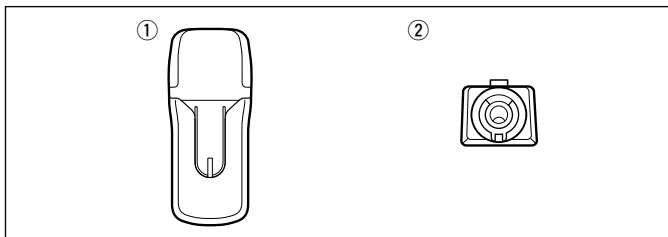

■ To attach

- ① Release the battery pack if it is attached. (p. 3)
- ② Slide the base clip in the direction of the arrow until the base clip is locked and makes a 'click' sound.

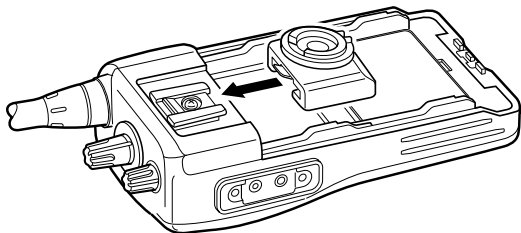

- ③ Clip the belt clip to a part of your belt. And insert the transceiver into the belt clip until the base clip inserted fully into the groove.

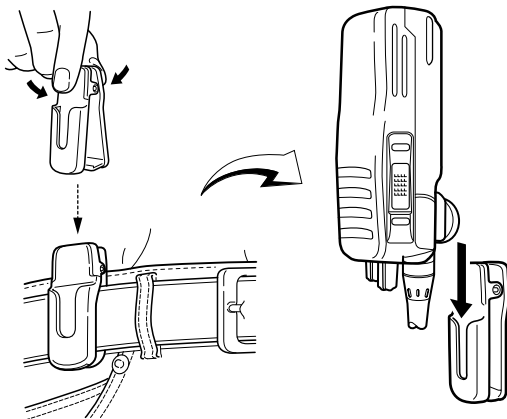

- ④ Once the transceiver is locked in place, it swivels as illustrated below.

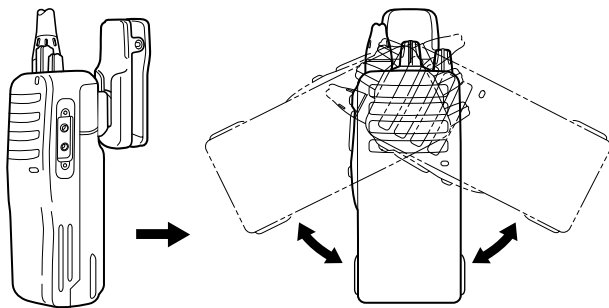

6 SWIVEL BELT CLIP

■ To detach

- ① Turn the transceiver upside down in the direction of the arrow and pull out from the belt clip.

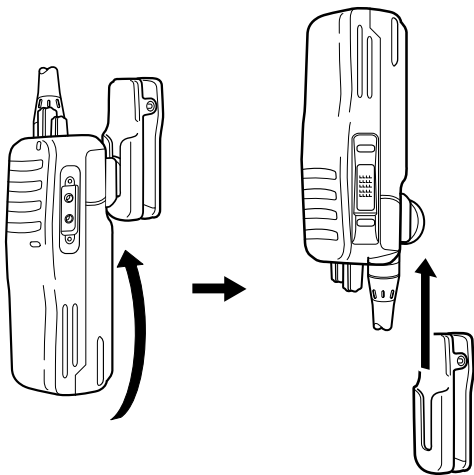

- ② Release the battery pack if it is attached. (p. 3)
- ③ Pinch the clip (①), and slide the base clip in the direction of the arrow (②).

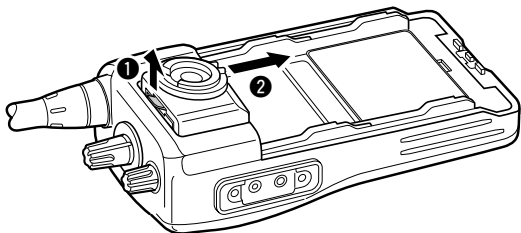

6

CAUTION:
HOLD THE TRANSCEIVER TIGHTLY, WHEN HANGING OR DETACHING THE TRANSCEIVER FROM THE BELT CLIP.
Otherwise the transceiver may not be attached to the holder or swivel properly if the transceiver is accidentally dropped and the base clip is scratched or damaged.

7 OPTIONS

◇ BATTERY PACK

- **BP-230** Li-Ion BATTERY PACK

7.4 V/800 mAh Li-Ion battery pack, allows approx. 5.5 hours* operation.

- **BP-231** Li-Ion BATTERY PACK

7.4 V/1150 mAh Li-Ion battery pack, allows approx. 8 hours* operation.

- **BP-232** Li-Ion BATTERY PACK

7.4 V/2000 mAh Li-Ion battery pack, allows approx. 14 hours* operation.

*Typical operation; Tx:Rx:Stand-by duty cycle=5:5:90

◇ CHARGERS

- **BC-119N** DESKTOP CHARGER + **AD-106** CHARGER ADAPTER + **BC-145** AC ADAPTER

For rapid charging of battery packs. An AC adapter is supplied with the charger depending on versions. Charging time: approx. 2 hours when BP-231 is attached.

- **BC-121N** MULTI-CHARGER + **AD-106** CHARGER ADAPTER (6 pcs.) + **BC-157** AC ADAPTER

For rapid charging of up to 6 battery packs (six AD-106's are required) simultaneously. An AC adapter should be purchased separately. Charging time: approx. 2 hours when BP-231 is attached.

- **BC-160** DESKTOP CHARGER + **BC-145** AC ADAPTER

For rapid charging of battery packs. An AC adapter is supplied with the charger depending on versions. Charging time: approx. 2 hours when BP-231 is attached.

◇ OPTIONAL UNITS

- **UT-108** DTMF DECODER UNIT

Provides pager and code squelch capabilities.

- **UT-109 (#01)/UT-110 (#01)** SCRAMBLER UNITS

Non-rolling type (UT-109)/Rolling type (UT-110) voice scrambler unit provides higher communication security.

- **UT-113** MAN DOWN UNIT

Provides a measure of safety when working in a hazardous environment, etc.

◇ BELT CLIPS

- **MB-93** SWIVEL BELT CLIP

- **MB-94** BELT CLIP

Exclusive alligator-type belt clip. The same as supplied with the transceiver.

- **MB-96*/96F** LEATHER BELT HANGER

*MB-93's base clip is required.

◇ DC CABLES

- **CP-17L** CIGARETTE LIGHTER CABLE

Allows charging of the battery pack through a 12 V cigarette lighter socket. (For BC-119N)

- **OPC-515L/OPC-656** DC POWER CABLES

Allows charging of the battery pack using a 13.8 V power source instead of the AC adapter.

OPC-515L: For BC-119N

OPC-656 : For BC-121N

◇ OTHER OPTIONS

- **SP-13** EARPHONE

Provides clear receive audio in noisy environment.

- **HM-131L** SPEAKER-MICROPHONE

Combination speaker-microphone that provides convenient operation while hanging the transceiver from your belt.

HM-131L has a moisture proof construction.

- **HS-94/HS-95/HS-97** HEADSET + **VS-1L** VOX/PTT CASE

HS-94: Ear hook type

HS-95: Neck-arm type

HS-97: Throat microphone

VS-1L: VOX/PTT switch box for hands-free operation, etc.

- **FA-SC73US/FA-SC56VS/FA-SC57VS** STUBBY ANTENNAS

FA-SC73US: 450–490 MHz

FA-SC56VS: 150–162 MHz

FA-SC57VS: 160–174 MHz

- **FA-SC25U/FA-SC57U/FA-SC72U/FA-SC25V/FA-SC55V** ANTENNAS

FA-SC25U: 400–430 MHz

FA-SC57U: 430–470 MHz

FA-SC72U: 470–520 MHz

FA-SC25V: 136–155 MHz

FA-SC55V: 146–174 MHz

Some options may not be available in some countries. Please ask your dealer for details.

◇ About VS-1L VOX/PTT CASE

The VS-1L is a VOX/PTT unit for Icom handheld transceivers, and allows you hands-free operation.

An optional headset (HS-94, etc.) is additionally required for operation.

- The VOX (voice operated transmission) function starts transmission without pushing PTT switch when you speak into the microphone; then, automatically returns to receive when you stop speaking.

Features

- Straight type head SP/MIC plug equipped
- Water resistant construction
- Durable construction
- Equipped with a PTT switch and revolving clip.

MIC/VOX gain adjustment

- 1 Remove the water protection cover on the right side of the VS-1L.
- 2 Adjust the MIC/VOX gain with a thin screw driver. Clockwise rotation increases the MIC/VOX gain.
- 3 Return the protective cover back to the MIC/VOX gain adjustment hole.

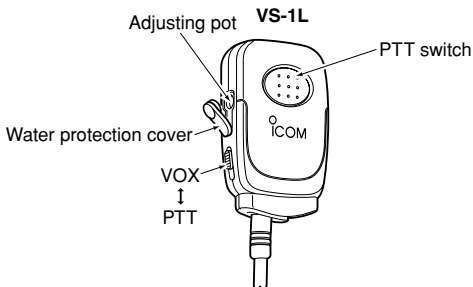

MEMO

Count on us!



A-6369D-1EX-⑤
Printed in Japan
© 2004–2006 Icom Inc.

Icom Inc.
1-1-32 Kamiminami, Hirano-ku, Osaka 547-0003, Japan